



# BUZZ



## Doon Public School

Dear Parents,  
Greetings!

### Please Note,

★ The **primary and preferred mode of communication** should be the school chronicle. Parents may call the school reception at **91-9592412833** or send a text message on the contact number of the concerned class teacher between **01:30 PM - 06:30 PM**.

★ We are sharing the details of class in-charges along with their contact information, kindly acknowledge and save the same.

<b>I A</b>	Ms. Ridhima	+91-6284189924
<b>I B</b>	Ms. Rishu	+91-8950352868
<b>II A</b>	Ms. Nandita	+91-7009701670
<b>II B</b>	Ms. Priyanka	+91-9646754372

★ The **Summer Break** will be from **May 27, 2023** to **July 4, 2023** (tentatively).

★ The **Syllabus** and **Monthly Planner** are shared on the school's website i.e. <https://www.doonpublicschoolpkl.com>.

★ You are requested to carefully go through the school chronicle especially pages no. **12 to 29**.

★ Kindly take note of the activities scheduled in May 2023,

~ Labour Day

~ Mother's Day

~ Skill of the Month : Social Skills

~ Skill Day : May 19, 2023

~ Birthday Theme : Space

(Colours to be worn - **Blue and White**)

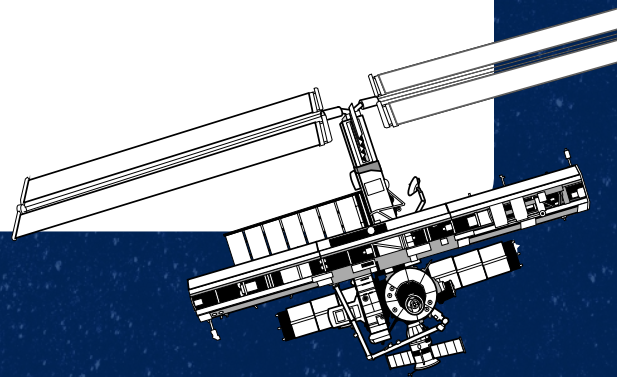



# LEADERS OF THE MONTH

May 2023

## Class Monitors



Pranaya  
IA

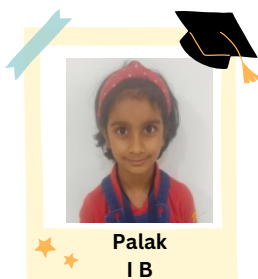

Palak  
IB



Vivan  
IIA

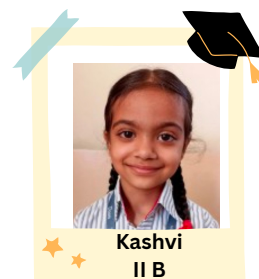

Kashvi  
IIB

## Shelf Monitors

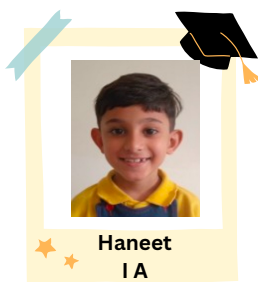

Haneet  
IA

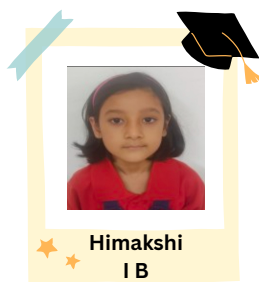

Himakshi  
IB

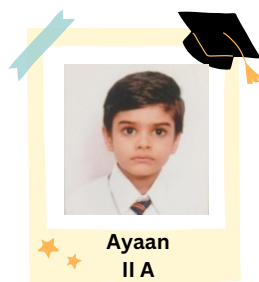

Ayaan  
IIA

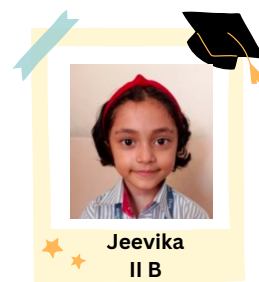

Jeevika  
IIB

## Board Monitors



Mivaan  
IA



Priyojit  
IB



Jashan  
IIA

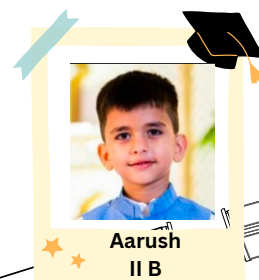

Aarush  
IIB

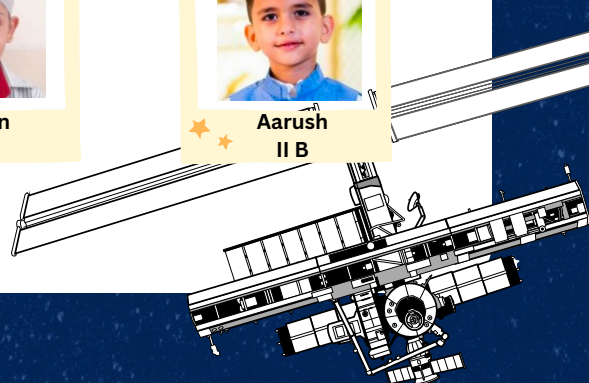



# Row Monitors



★ ★  
**Lavisha**  
IA



★ ★  
**Namish**  
IA

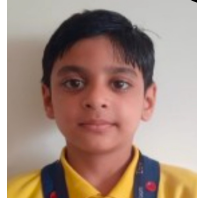

★ ★  
**Shaurya**  
IA



★ ★  
**Kiara**  
IB



★ ★  
**Sukhreet**  
IB

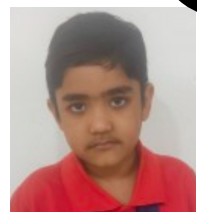

★ ★  
**Adhvik**  
IB



★ ★  
**Sohika**  
II A



★ ★  
**Saanvi**  
II A



★ ★  
**Sidhant**  
II A

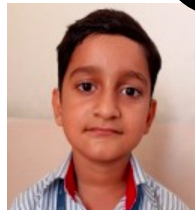

★ ★  
**Devansh**  
II B



★ ★  
**Aayansh**  
II B



★ ★  
**Yashaswi**  
II B

